

User

Kubitech S.R.L.

Verification Unit cooler

vineri.17.03.2017

Air inlet temperature	°C	0	Evaporating temperature	°C	-10,0
TD	°C	10,0	Refrigerant		R404A
Min number of units in room		1			

Heat exchanger	Standard	Casing	Standard
Motorfans feed	Standard	Fan motors	Standard
Defrost	Electric		

Selected model: 1 x CTE 86M6 ED

Capacity	kW	5,659			
TD	°C	10,0	Tot. air flow	m3/h	2250

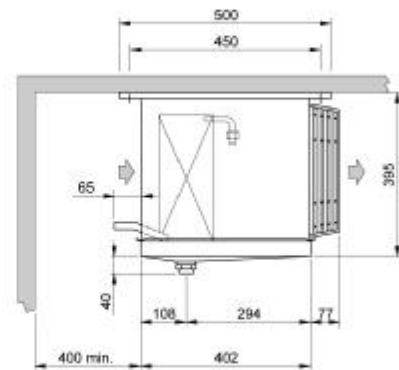
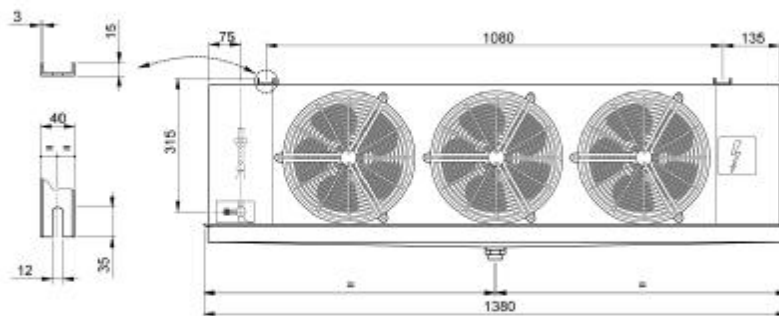

Weight	kg	39,800			
Internal surface	m2	3,17	External surface	m2	19,98
Input connection		1/2" SAE	Output connection		22 mm
Total circuit capacity	dm3	6,35	Fin spacing	mm	6
Drain connection		1" GAS			
Defrost	ED	Electric		Watt	1800
Fan	n.	3	Diameter	mm	250
Air flow	m3/h	2250	Air throw	m	11,0
Feed	V	230/1/50-60	Fan speed	rpm	1300
Fan	A	1,41	Total power	Watt	225
Tot. Pres.S.Lev. 10 m.	dB(A)	36			

N.B.: we shall not be liable for the performances and the quality of sold products, if fitted or connected to fan motor speed regulation or control systems that are different from the ones proposed or installed by us.