

User

Kubitech S.R.L.

Verification Unit cooler

vineri.17.03.2017

Air inlet temperature	°C	0	Evaporating temperature	°C	-10,0
TD	°C	10,0	Refrigerant		R404A
Min number of units in room		1			

Heat exchanger	Standard	Casing	Standard
Motorfans feed	Standard	Fan motors	Standard
Defrost	Electric		

Selected model: 1 x CTE 501E6 ED

Capacity	kW	11,954			
TD	°C	10,0	Tot. air flow	m3/h	7620

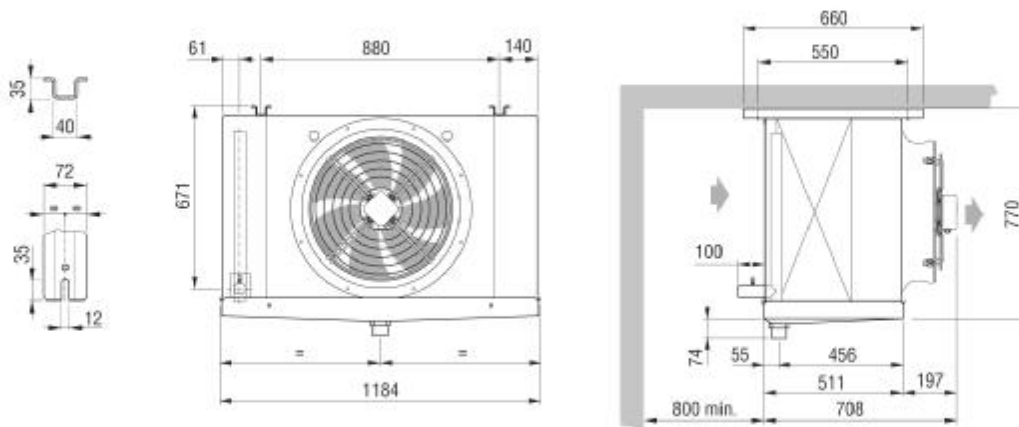

Weight	kg	61,000			
Internal surface	m2	4,30	External surface	m2	24,40
Input connection		16 mm	Output connection		28 mm
Total circuit capacity	dm3	7,80	Fin spacing	mm	6
Drain connection		2" GAS			
Defrost	ED	Electric		Watt	5040
Fan	n.	1	Diameter	mm	500
Air flow	m3/h	7620	Air throw	m	28,0
Feed	V	400/3/50	Fan speed	rpm	1390
Fan	A	1,8	Total power	Watt	860
Tot. Pres.S.Lev. 10 m.	dB(A)	52			

N.B.: we shall not be liable for the performances and the quality of sold products, if fitted or connected to fan motor speed regulation or control systems that are different from the ones proposed or installed by us.