

User

Kubitech S.R.L.

Verification Unit cooler

vineri.17.03.2017

Air inlet temperature	°C	0	Evaporating temperature	°C	-10,0
TD	°C	10,0	Refrigerant		R404A
Min number of units in room		1			

Heat exchanger	Standard	Casing	Standard
Motorfans feed	Standard	Fan motors	Standard
Defrost	Electric		

Selected model: 1 x CTE 502A6 ED

Capacity	kW	30,868			
TD	°C	10,0	Tot. air flow	m3/h	14240

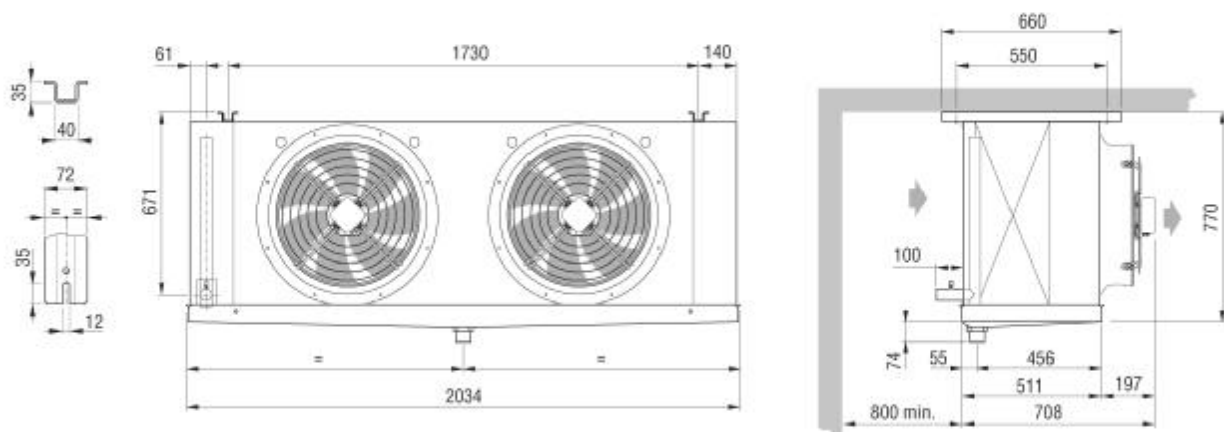

Weight	kg	125,000			
Internal surface	m2	12,80	External surface	m2	73,20
Input connection		22 mm	Output connection		35 mm
Total circuit capacity	dm3	22,60	Fin spacing	mm	6
Drain connection		2" GAS			
Defrost	ED	Electric		Watt	10200
Fan	n.	2	Diameter	mm	500
Air flow	m3/h	14240	Air throw	m	29,0
Feed	V	400/3/50	Fan speed	rpm	1390
Fan	A	3,6	Total power	Watt	1720
Tot. Pres.S.Lev. 10 m.	dB(A)	55			

N.B.: we shall not be liable for the performances and the quality of sold products, if fitted or connected to fan motor speed regulation or control systems that are different from the ones proposed or installed by us.