

User

Kubitech S.R.L.

Verification Unit cooler

vineri.17.03.2017

Air inlet temperature	°C	0	Evaporating temperature	°C	-10,0
TD	°C	10,0	Refrigerant		R404A
Min number of units in room		1			

Heat exchanger	Standard	Casing	Standard
Motorfans feed	Standard	Fan motors	Standard
Defrost	Electric		

Selected model: 1 x CTE 631B6 ED

Capacity	kW	38,132			
TD	°C	10,0	Tot. air flow	m3/h	14470

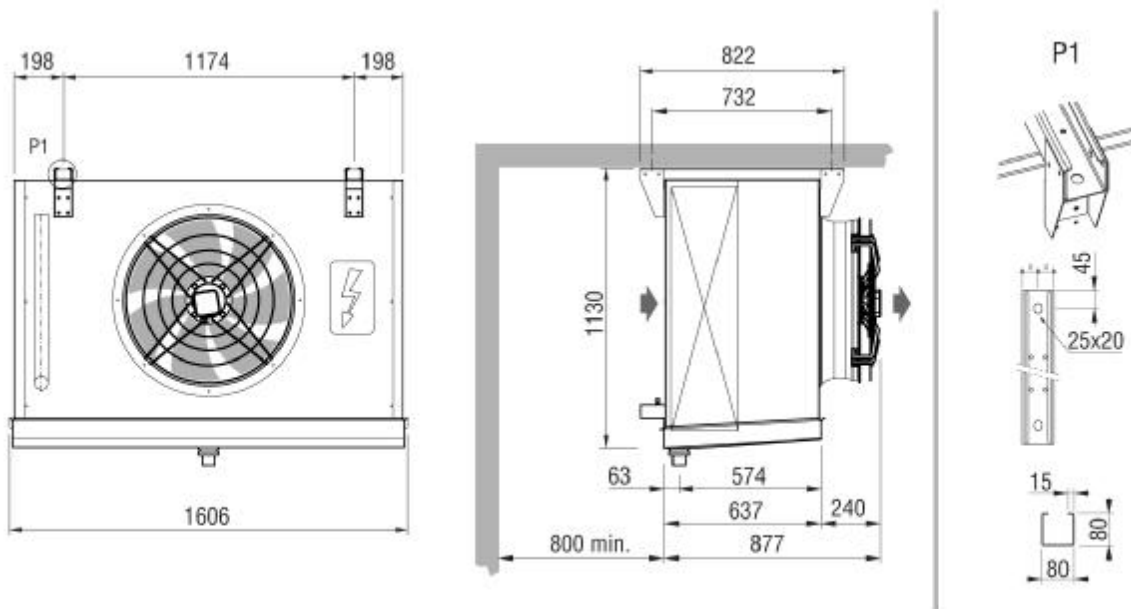

Weight	kg	120,000			
Internal surface	m2	14,00	External surface	m2	91,00
Input connection		28 mm	Output connection		42 mm
Total circuit capacity	dm3	28,00	Fin spacing	mm	6
Drain connection		2" GAS			
Defrost	ED	Electric		Watt	10800
Fan	n.	1	Diameter	mm	630
Air flow	m3/h	14470	Air throw	m	28,0
Feed	V	400/3/50	Fan speed	rpm	1400
Fan	A	3,7	Total power	Watt	1750
Tot. Pres.S.Lev. 10 m.	dB(A)	47			

N.B.: we shall not be liable for the performances and the quality of sold products, if fitted or connected to fan motor speed regulation or control systems that are different from the ones proposed or installed by us.