

User

Kubitech S.R.L.

Verification Unit cooler

vineri.17.03.2017

Air inlet temperature	°C	0	Evaporating temperature	°C	-10,0
TD	°C	10,0	Refrigerant		R404A
Min number of units in room		1			

Heat exchanger	Standard	Casing	Standard
Motorfans feed	Standard	Fan motors	Standard
Defrost	Electric		

Selected model: 1 x CTE 632A6 ED

Capacity	kW	65,520			
TD	°C	10,0	Tot. air flow	m3/h	30160

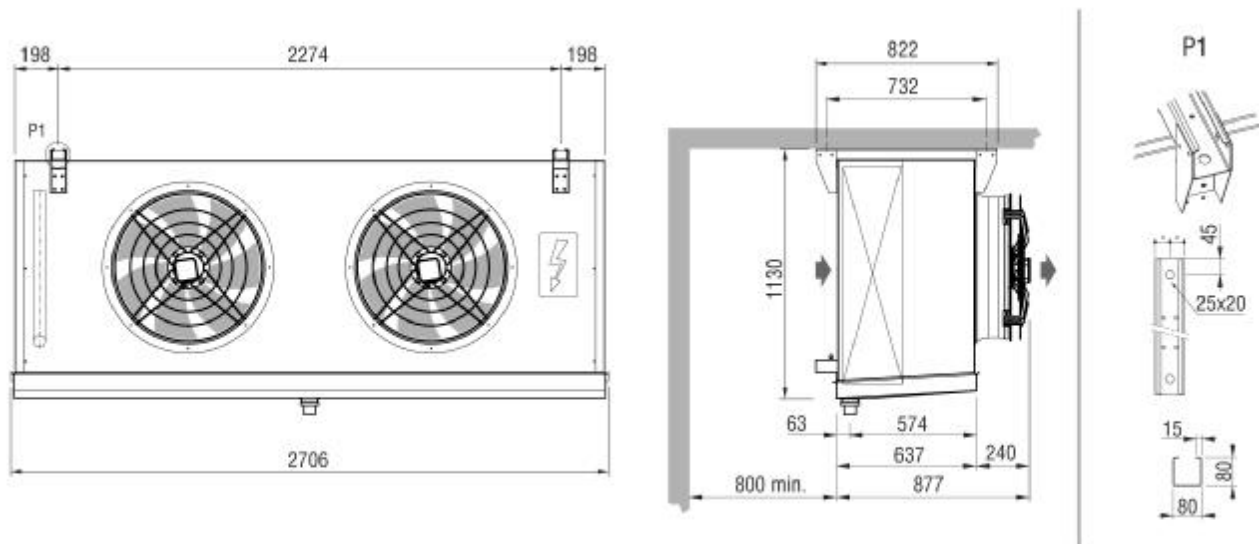

Weight	kg	210,000			
Internal surface	m2	21,00	External surface	m2	137,00
Input connection		35 mm	Output connection		54 mm
Total circuit capacity	dm3	42,00	Fin spacing	mm	6
Drain connection		2" GAS			
Defrost	ED	Electric		Watt	17640
Fan	n.	2	Diameter	mm	630
Air flow	m3/h	30160	Air throw	m	33,0
Feed	V	400/3/50	Fan speed	rpm	1400
Fan	A	7,4	Total power	Watt	3500
Tot. Pres.S.Lev. 10 m.	dB(A)	50			

N.B.: we shall not be liable for the performances and the quality of sold products, if fitted or connected to fan motor speed regulation or control systems that are different from the ones proposed or installed by us.