

User

[www.frigotehnie.ro](http://www.frigotehnie.ro)

Verification Unit cooler

vineri.17.03.2017

|                             |    |       |                         |    |       |
|-----------------------------|----|-------|-------------------------|----|-------|
| Air inlet temperature       | °C | -18,0 | Evaporating temperature | °C | -25,0 |
| TD                          | °C | 7,0   | Refrigerant             |    | R404A |
| Min number of units in room |    | 1     |                         |    |       |

|                |          |            |          |
|----------------|----------|------------|----------|
| Heat exchanger | Standard | Casing     | Standard |
| Motorfans feed | Standard | Fan motors | Standard |
| Defrost        | Electric |            |          |

Selected model: 1 x CTE 23L8 ED

|          |    |       |               |      |     |
|----------|----|-------|---------------|------|-----|
| Capacity | kW | 1,015 |               |      |     |
| TD       | °C | 7,0   | Tot. air flow | m3/h | 780 |

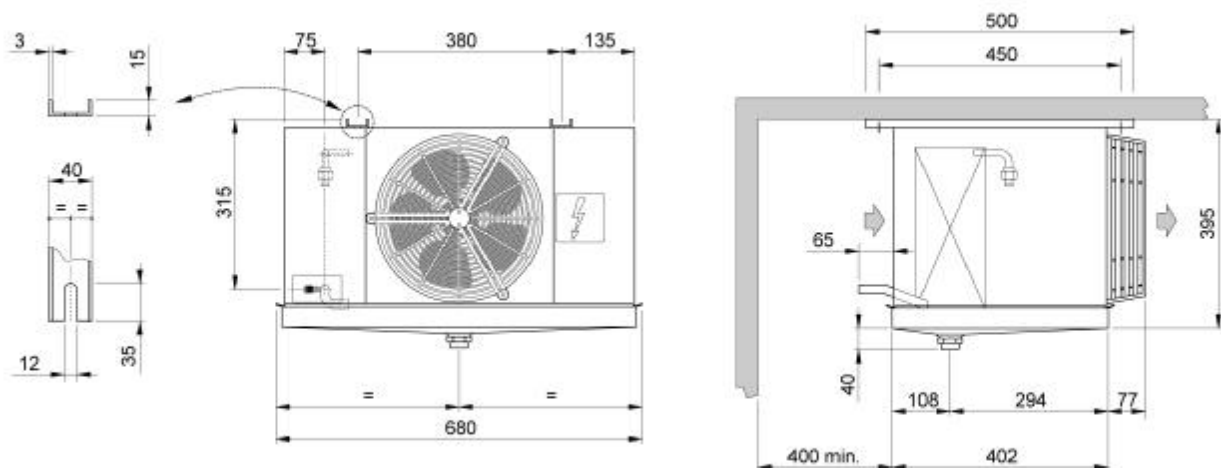

|                        |       |             |                   |      |       |
|------------------------|-------|-------------|-------------------|------|-------|
| Weight                 | kg    | 16,400      |                   |      |       |
| Internal surface       | m2    | 1,06        | External surface  | m2   | 4,91  |
| Input connection       |       | 1/2" SAE    | Output connection |      | 16 mm |
| Total circuit capacity | dm3   | 2,34        | Fin spacing       | mm   | 8.5   |
| Drain connection       |       | 1" GAS      |                   |      |       |
| Defrost                | ED    | Electric    |                   | Watt | 750   |
| Fan                    | n.    | 1           | Diameter          | mm   | 250   |
| Air flow               | m3/h  | 780         | Air throw         | m    | 8,0   |
| Feed                   | V     | 230/1/50-60 | Fan speed         | rpm  | 1300  |
| Fan                    | A     | 0,47        | Total power       | Watt | 75    |
| Tot. Pres.S.Lev. 10 m. | dB(A) | 31          |                   |      |       |

N.B.: we shall not be liable for the performances and the quality of sold products, if fitted or connected to fan motor speed regulation or control systems that are different from the ones proposed or installed by us.