

User

www.frigotehnie.ro

Verification Unit cooler

vineri.17.03.2017

Air inlet temperature	°C	-18,0	Evaporating temperature	°C	-25,0
TD	°C	7,0	Refrigerant		R404A
Min number of units in room		1			

Heat exchanger	Standard	Casing	Standard
Motorfans feed	Standard	Fan motors	Standard
Defrost	Electric		

Selected model: 1 x CTE 28L8 ED

Capacity	kW	1,170			
TD	°C	7,0	Tot. air flow	m3/h	840

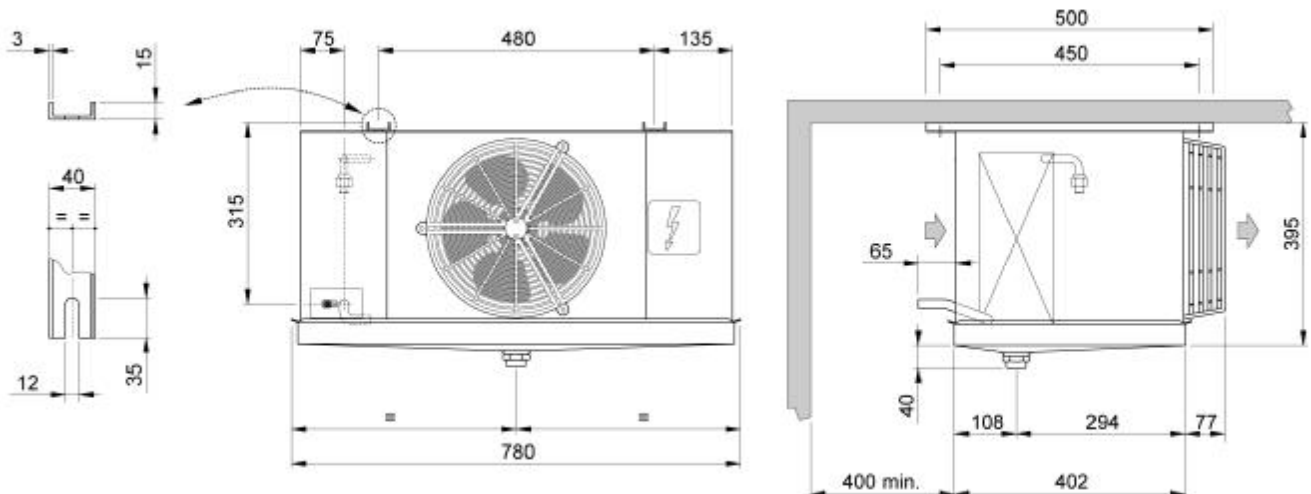

Weight	kg	19,200			
Internal surface	m2	1,40	External surface	m2	6,20
Input connection		1/2" SAE	Output connection		16 mm
Total circuit capacity	dm3	3,00	Fin spacing	mm	8.5
Drain connection		1" GAS			
Defrost	ED	Electric	Watt		1350
Fan	n.	1	Diameter	mm	250
Air flow	m3/h	840	Air throw	m	9,0
Feed	V	230/1/50-60	Fan speed	rpm	1300
Fan	A	0,47	Total power	Watt	75
Tot. Pres.S.Lev. 10 m.	dB(A)	31			

N.B.: we shall not be liable for the performances and the quality of sold products, if fitted or connected to fan motor speed regulation or control systems that are different from the ones proposed or installed by us.