

User

www.frigotehnie.ro

Verification Unit cooler

vineri.17.03.2017

Air inlet temperature	°C	-18,0	Evaporating temperature	°C	-25,0
TD	°C	7,0	Refrigerant		R404A
Min number of units in room		1			

Heat exchanger	Standard	Casing	Standard
Motorfans feed	Standard	Fan motors	Standard
Defrost	Electric		

Selected model: 1 x CTE 125L8 ED

Capacity	kW	5,667			
TD	°C	7,0	Tot. air flow	m3/h	4900

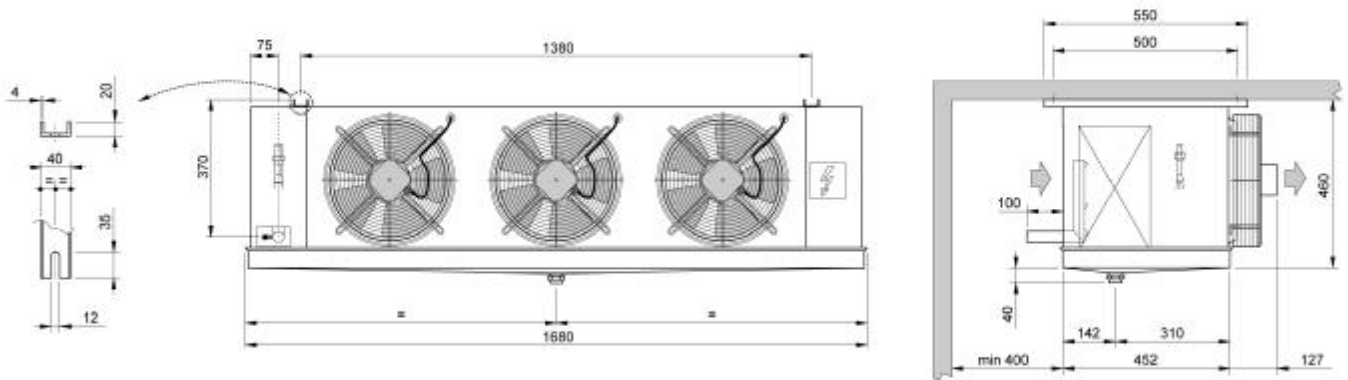

Weight	kg	54,200			
Internal surface	m2	4,58	External surface	m2	21,29
Input connection		1/2" SAE	Output connection		28 mm
Total circuit capacity	dm3	8,06	Fin spacing	mm	8.5
Drain connection		1" GAS			
Defrost	ED	Electric		Watt	3990
Fan	n.	3	Diameter	mm	315
Air flow	m3/h	4900	Air throw	m	18,0
Feed	V	230/1/50-60	Fan speed	rpm	1370
Fan	A	1,51	Total power	Watt	330
Tot. Pres.S.Lev. 10 m.	dB(A)	44			

N.B.: we shall not be liable for the performances and the quality of sold products, if fitted or connected to fan motor speed regulation or control systems that are different from the ones proposed or installed by us.